

Pressurized Inspection Sheet

FOR USE WITH CD1500P & CD2000P

Ozone generator model: _____
 Ozone serial number: _____
 Oxygen concentrator: _____
 Oxygen serial number: _____
 Date of inspection: _____
 Date of installation: _____
 Inspector name: _____
 Contact #/email: _____

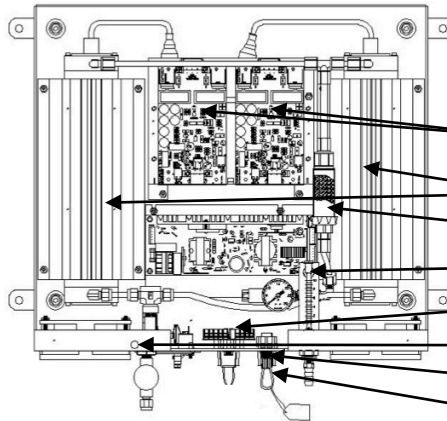

Shown: CD2000P

- Drive Board and Drive Transformers (Under Boards)
- Reaction Chambers
- Inline Particulate Filter
- Power Supplies
- 4-20mA Control Board
- Cover Safety Switch
- Potentiometer (Ozone output control)
- External Loop

When performing an inspection or troubleshooting a system please complete this form.
 For troubleshooting assistance, it can be emailed to service@cwtozone.com or faxed to 805-549-0306.

1. Drive System Version

Consult the High Output Drive Component Selection supplement at the end of this form to note the version drive board, transformer and power supply installed in your system.

Note: If the power supply of your system does not match that pictured in the supplement, note your power supply version as “old”

Drive board version: _____ (CCA1231 / ELPC5215 / ELPC5210)
 Transformer version: _____ (HVT275 / HVT250 / HVT200)
 Power supply version: _____ (Current / Old)

Shown: CCA1231 Drive Board LEDs

2. Display Lights

Observe the status of the lights on the drive board, control board, and power supply boards within the ozone generator.
 To access the lights: Remove the cover, manually depress the door safety switch and power the unit for ozone operation.

If no lights are visible on any board, confirm the cooling fans are spinning. If there is no fan movement, re-check the cover safety switch, on/off switch and fuses.

Drive board LED status:

Note: The status of the lights will vary depending on board version. On the ELPC5200 version, there are only two lights, Power (green) and Ozone (red), adjust the responses accordingly.

Ozone LED -Amber: _____ (On / Off)
 Power -XMFR -Green: _____ (On / Off)
 Power - 12V -Green: _____ (On / Off)
 Fault LED -Red: _____ (On / Off /Flashing -1, 2, or 3 beat pattern)

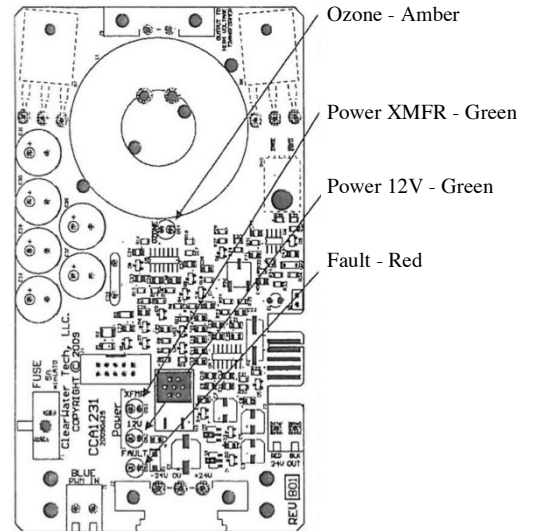

If the Ozone LED is illuminated, rotate the potentiometer knob located on the underside of the ozone generator to vary the ozone output; does the Ozone LED adjust accordingly?

Control of Ozone LED: _____ (Yes / No)



Pressurized Inspection Sheet

FOR USE WITH CD1500P & CD2000P

If the Ozone LED is not illuminated, but both green power lights are illuminated, perform the following test. Disconnect power from the ozone generator, disconnect the blue PWM wire from the drive board(s), then power the system and attempt ozone generation; does the Ozone LED illuminate now?

Ozone LED with Blue wire disconnected: _____ (On / Off)

Power supply LED status:

The current version power supply boards have a green LED in a corner of the boards indicating they are powered properly, consult the status of this LED on both power supply boards.

Power LED -Green: _____ (Both on / One on / Both off) Green

Control Board LED status:

The (4-20mA) control board located at the bottom of the unit, and is indicated on the above illustration. A red LED will illuminate on this board when the external loop circuit is opened, this will disable ozone output. Consult the manual for more information on the external loop circuit.

Control LED -Red: _____ (On / Off)

3. Gauge Readings

If a gauge assembly is installed, mark or list the readings observed during normal operation.

PSI: _____ (Expected: 9-11 PSI)

CFH: _____ (Expected: 3-4 CFH for CD1500P, 6-8 CFH for CD2000P)

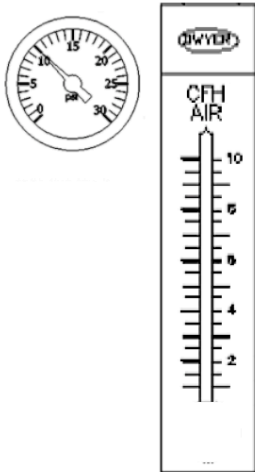

4. Colored Crystals

Look for the inline particulate filter within the ozone generator. The color of the media serves as a status check of the air dryer or oxygen concentrator.

The normal color for the inline particulate filter is blue.

Any moisture passing through this media will be absorbed by the media and produce a color change from blue, to pink and finally to white. This serves as a status check of the air dryers or oxygen concentrators.

Color of media: _____ (Blue / Pink / White / Other)

Inline Particulate Filter



ClearWater Tech, LLC.

1.800.262.0203 • 805.549-9724

850-E Capitolio Way, San Luis Obispo, CA 93401 • email: service@cwtozone.com • www.cwtozone.com

Pressurized Inspection Sheet

FOR USE WITH CD1500P & CD2000P

5. Vacuum Break Status

If a vacuum break is installed, confirm there is water present within the riser tube and there are no bubbles in this water. If there are bubbles, confirm their direction of flow: up or down the riser tube.

Water present: _____ (Yes / No)
 Air bubbles: _____ (Yes / No)
 Bubble direction: _____ (Up / Down / NA)

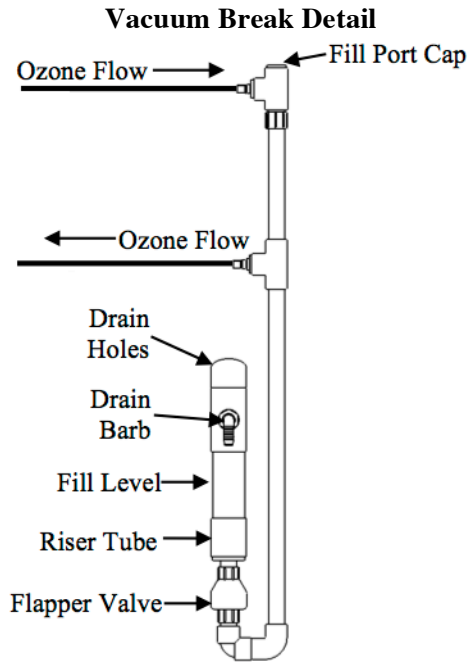

6. Off Gas Vent Status

If a contact tank is installed downstream of the venturi injector, there will be an off gas vent present on top of the tank.

Under normal operation, water should be present within the clear bowl with air bubbling up regularly and flowing out of the outlet.

If the ozone generator is suspected of not generating ozone, check the vent's outlet for the smell of ozone (direct airflow over your hand, do not inhale directly).

Water level: _____ (None / At water level / Full)
 Air venting: _____ (Yes / No)
 Ozone scent: _____ (Yes / No)

Off Gas Vent

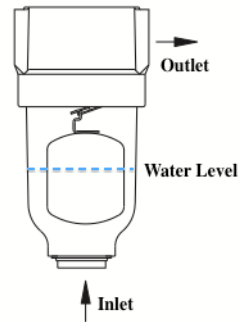

High Output Drive Component Selection

Over the last few years we've upgraded and enhanced the drive system (this is the drive board and high output transformer assembly) in some of our higher output ozone generators. When it comes time to replace a drive board or transformer, these version changes do make it more complicated to get the correct component, as **the drive board needs to be used with its intended transformer**. If the pictured transformers do not match what is in your ozone generator, there's no need to read on as it this does not apply to your model ozone generator.

When replacing a component of a drive system there are two options: Order the correct version component (if available), or upgrade to the current revision.

To find out what version components you require for your drive system, first compare the high output transformers pictured below to the transformer(s) in the ozone generator. Pictures of the associated version drive board are included.

Pictured to the right are the current transformer, the HVT275 and the current drive board CCA1231.

Replacement transformers are available; the part number is HVT275SA.

Replacement drive boards are available for this transformer; the part number is CCA1231SA.

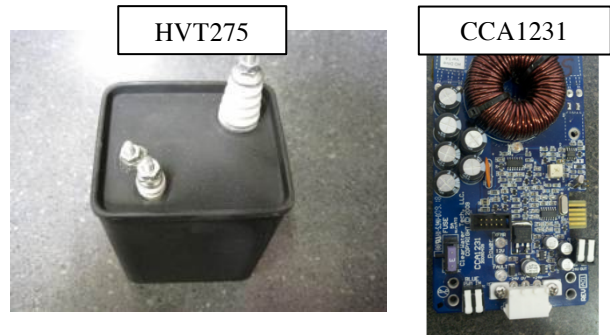

Pictured are the HVT250, sometimes listed as the HVT255, transformer and the associated drive board is the ELPC5215.

If you require a replacement transformer of this type, unfortunately, it is no longer available. You will need to install a drive upgrade kit, listed below (see Upgrading section).

Drive boards for this version transformer are available; the part number is ELPC5215SA.

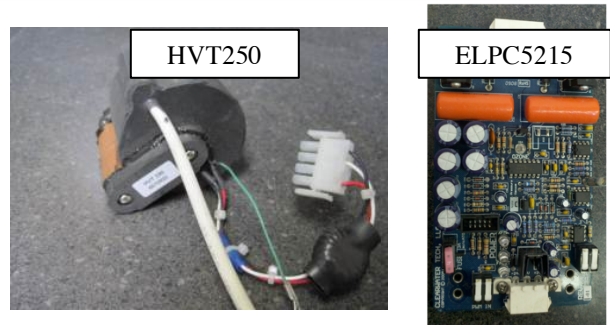

Pictured are the HVT200 transformer and the associated drive boards, ELPC5210 and ELPC5200.

If you require a replacement transformer of this type, unfortunately, it is also no longer available. You will need to install an upgrade kit, listed below (see Upgrading section).

If you require a replacement drive board for this transformer, a compatibility test will have to be performed. The ELPC5200 is no longer available.

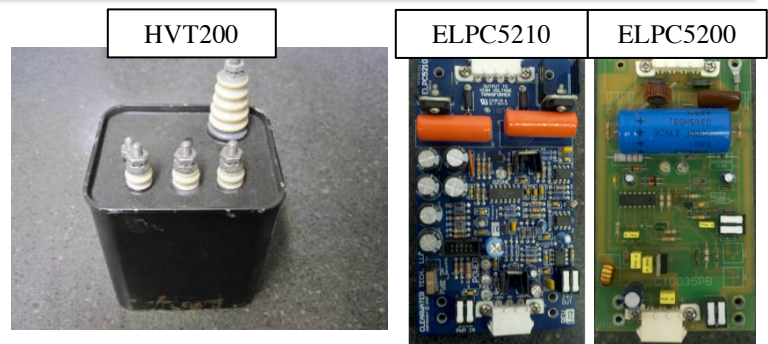

Note: The ELPC5215 and ELPC5210 are nearly identical. Look for the part number labeled on the board, or identify the transformer version to select the correct drive board.



ClearWater Tech, LLC.

1.800.262.0203 • 805.549-9724

850-E Capitolio Way, San Luis Obispo, CA 93401 • email: service@cwtozone.com • www.cwtozone.com

High Output Drive Component Selection

HVT200 – ELPC5210 Compatibility Test

Follow these steps:

- Scrape away a small portion of the black paint on any side other than the top (the top has the five connection points). The underside of the transformer is recommended.
- If the material under the black paint is aluminum, the drive board compatible with this transformer is no longer available, install a drive upgrade kit, listed below (see Upgrading section).
- If the material is copper, you can order a replacement board.

The part number for a replacement drive board for the HVT200 (copper) is ELPC5210SA. Here is a sample photo of the underside of a HVT200 transformer that displays copper. Your transformer's color should be easily identifiable like this example.



Upgrading

Upgrading the drive system is only necessary if you require a replacement transformer. If you require a replacement drive board because of the usual heat, age, and environmental issues, these boards are still available. Consider upgrading to the current drive system if you are replacing an older drive board; the price is comparable.

Upgrade kits are sorted by model number of the ozone generator. The kits include the current transformer and drive board system, hardware specific to the generator, and installation instructions. For dual drive systems, you have the option of upgrading just one half of the drives, or the complete drive system.

Model CD2000 & CD2000P (These systems have two drive systems)

Upgrade kit for single drive: HVT204SA

Upgrade kit for both drives: DRM60SA

Model CD1500 & CD1500P (A15e)

Upgrade kit for drive system: HVT205SA

Important: If your power supply is of an older version, it will also need to be upgraded in order for the current drive system to operate properly.

Pictured is the current version power supply.

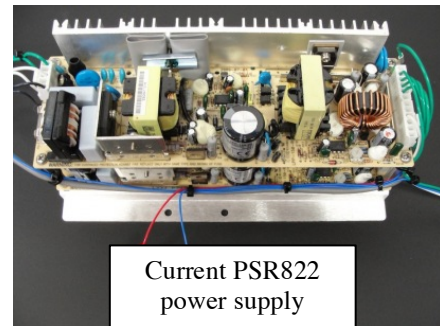

PSR822 Power Supply

If the currently installed power supply differs from the power supply pictured, **and the drive system is being upgraded**, the power supply will need to be upgraded as well.

Upgrade kit for power supply: PSR1500SA

Model CD15/AD

Upgrade kit for drive system: HVT206SA

All other generator models have the drive system mount directly to the reaction chamber. These models include: SC27P, Mobile Wash Carts, and the HO and P versions of cabinets (example: CD8000P and CD12000HO)

Upgrade kit for single drive system: HVT207SA

Note: When installing the upgrade kit, new holes will have to be drilled into the heat sink to mount all four corners. Installing only using two points is an option, assuming you are not shipping the system.



ClearWater Tech, LLC.

1.800.262.0203 • 805.549-9724

850-E Capitolio Way, San Luis Obispo, CA 93401 • email: service@cwtozone.com • www.cwtozone.com